

# Smart WiFi Touch Switch

US Standard | 1-Gang | For Lamps

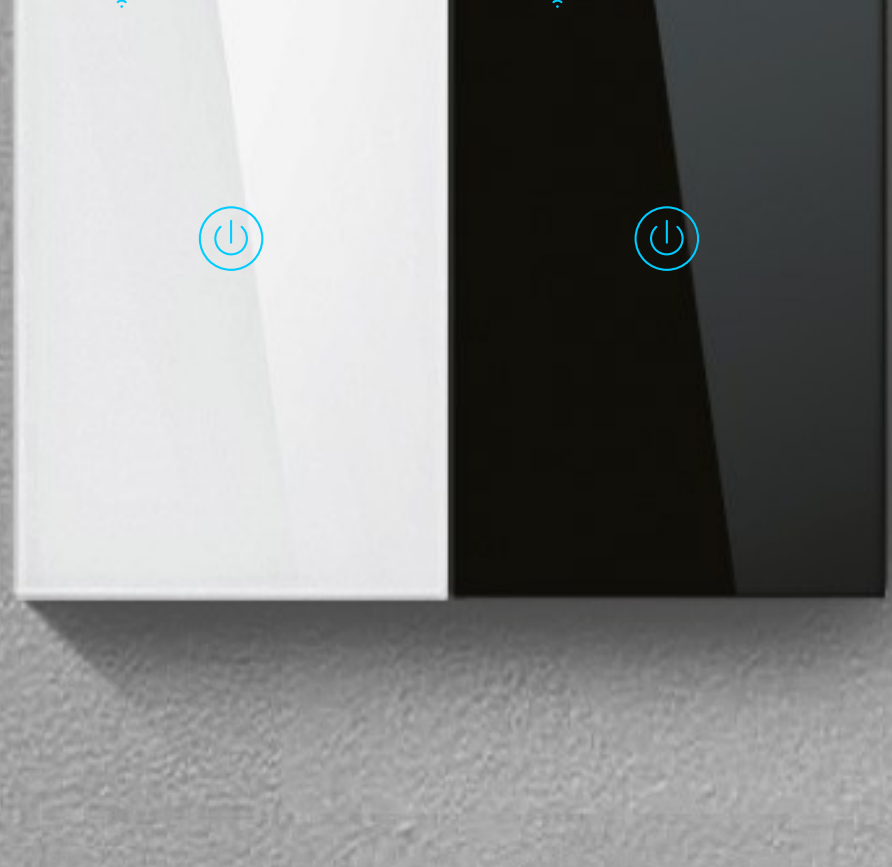

Focus the quality of life, lead the trend of switch  
LED Backlight, Multiple Non-interfering Control Modes  
10-400W rated power suitable for various lights  
Work with Amazon Alexa/Google Assistance

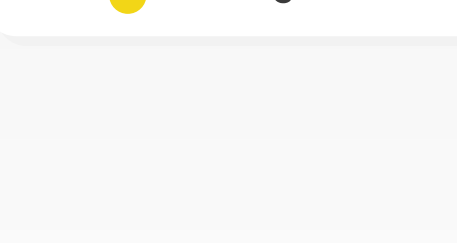

WiFi Connection



Remote Control



Voice Control



Timing Schedules



Glass Panel



Touch Control

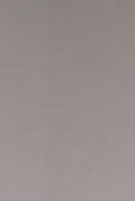

LED Backlight



Device Sharing

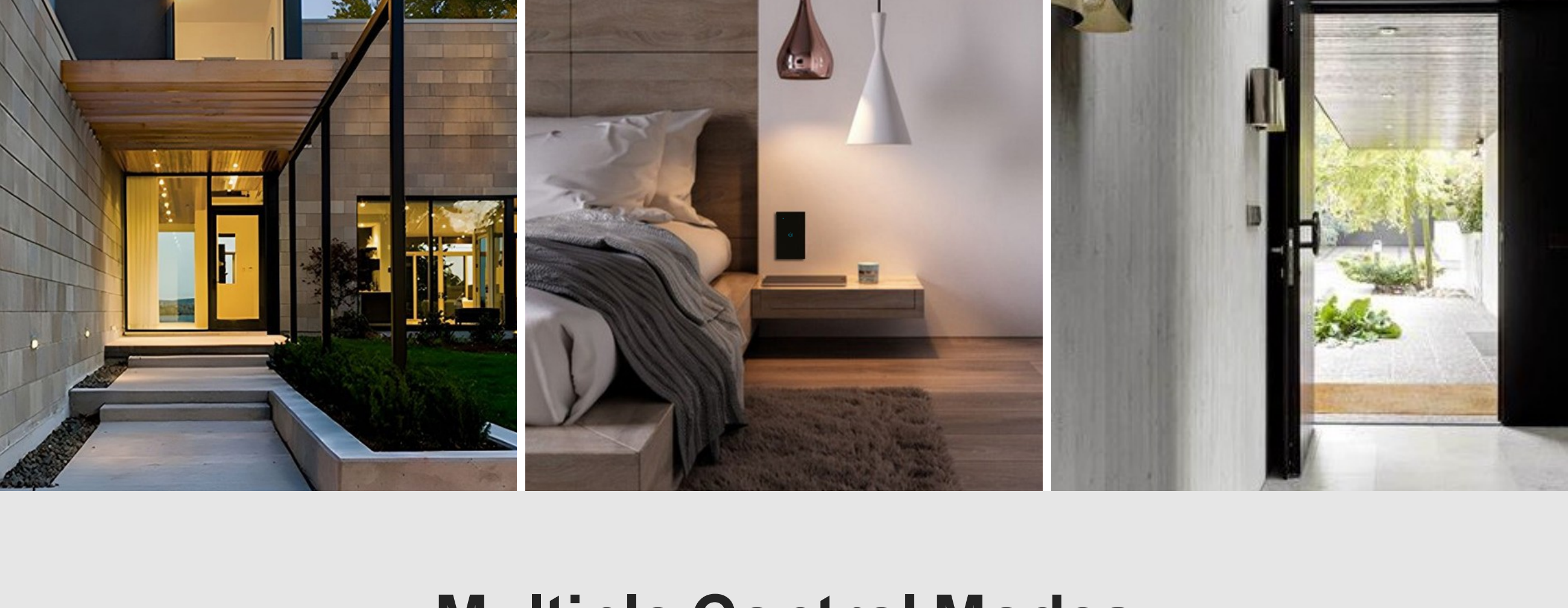

## Multiple Control Modes

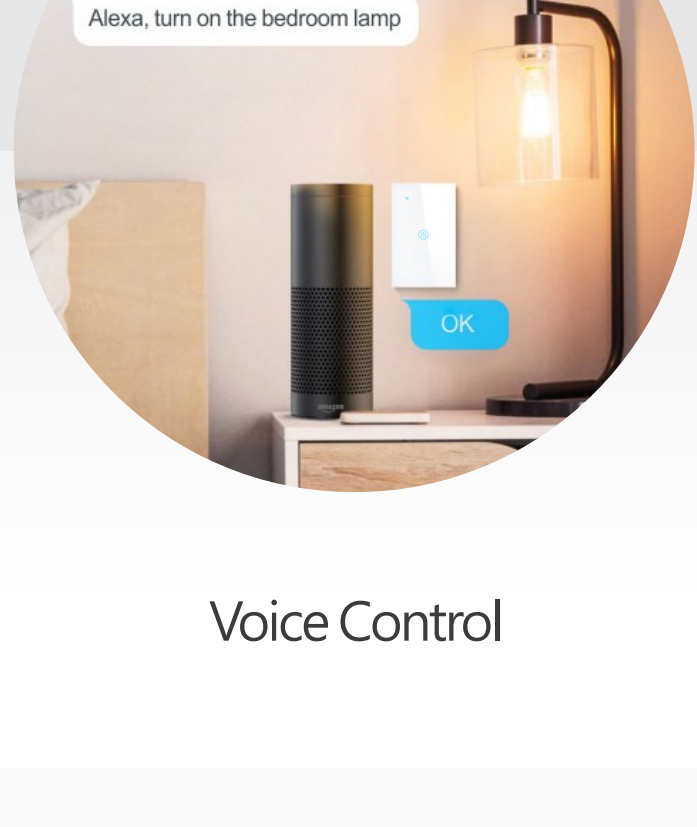

Voice Control

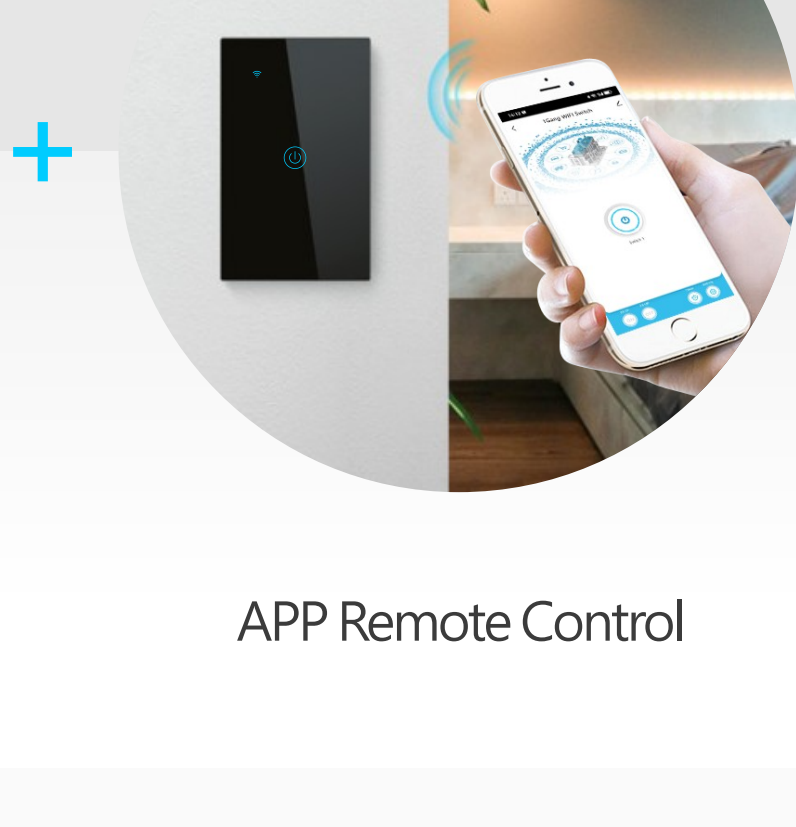

APP Remote Control

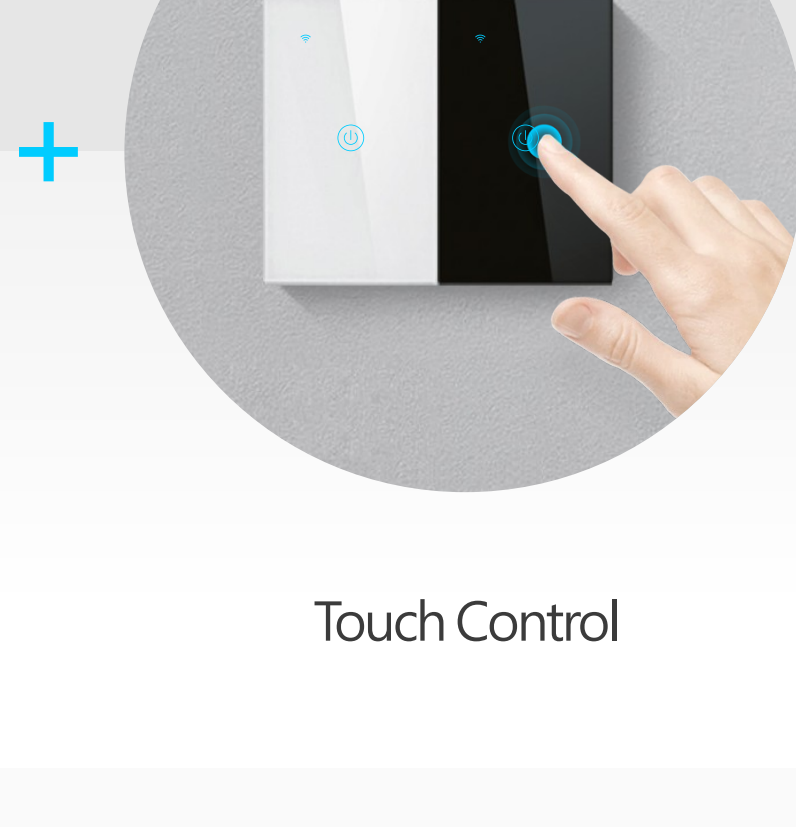

Touch Control



## Tuya Smart

Smart Life Smart Living

### What is the tuya?

Remotely control home appliances from anywhere  
Add and control multiple devices at once with one App  
Voice control via Amazon Echo and Google Home  
Interworking of multiple smart devices.  
Devices automatically start/stop working based on temperature, location and time.  
Easily share devices among family members  
Receive real-time alerts to ensure safety  
Easily and quickly connect Tuya Smart App to devices

## Control Switch with Your Voice

Work with Amazon Alexa/Google Assistance

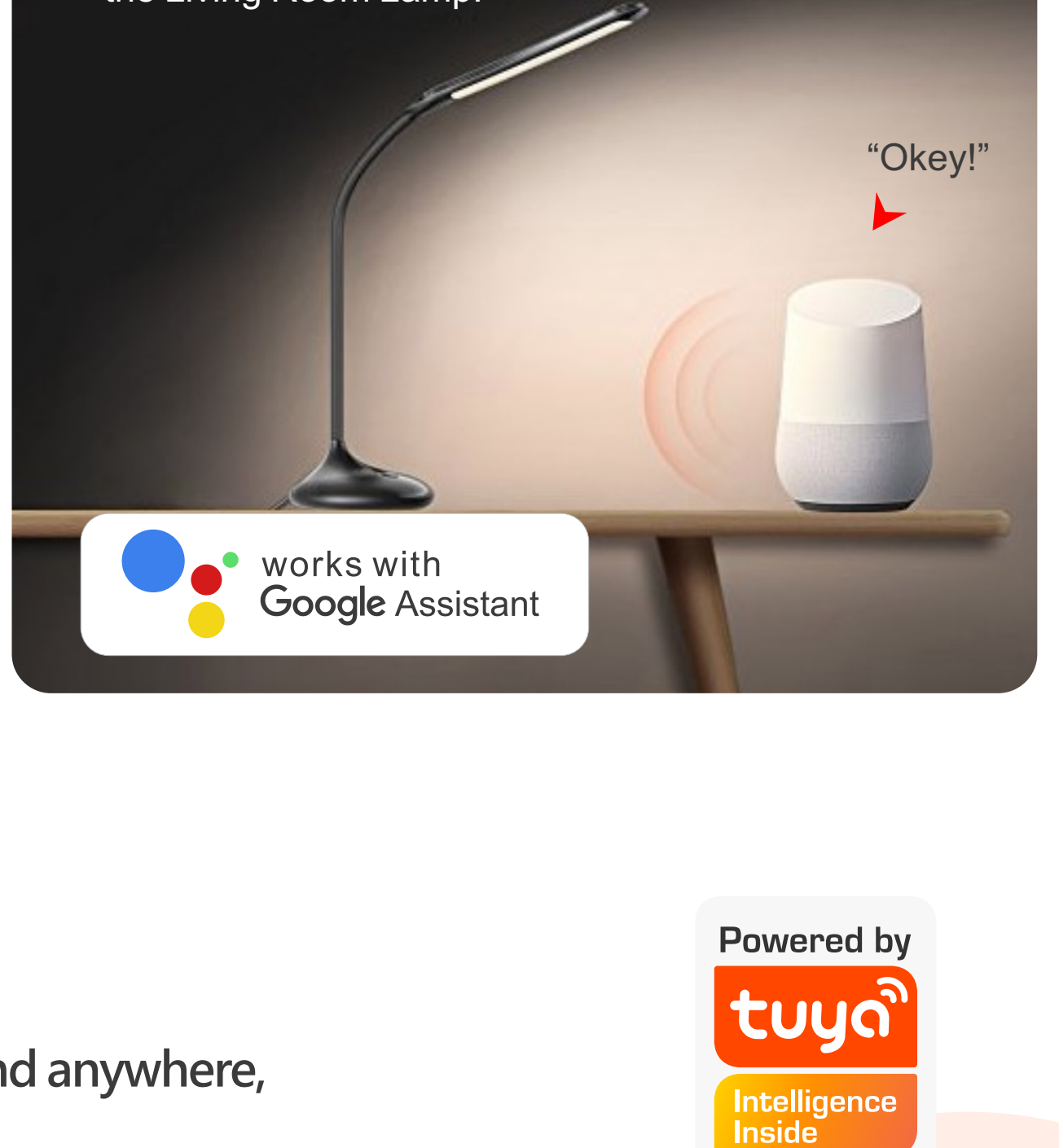
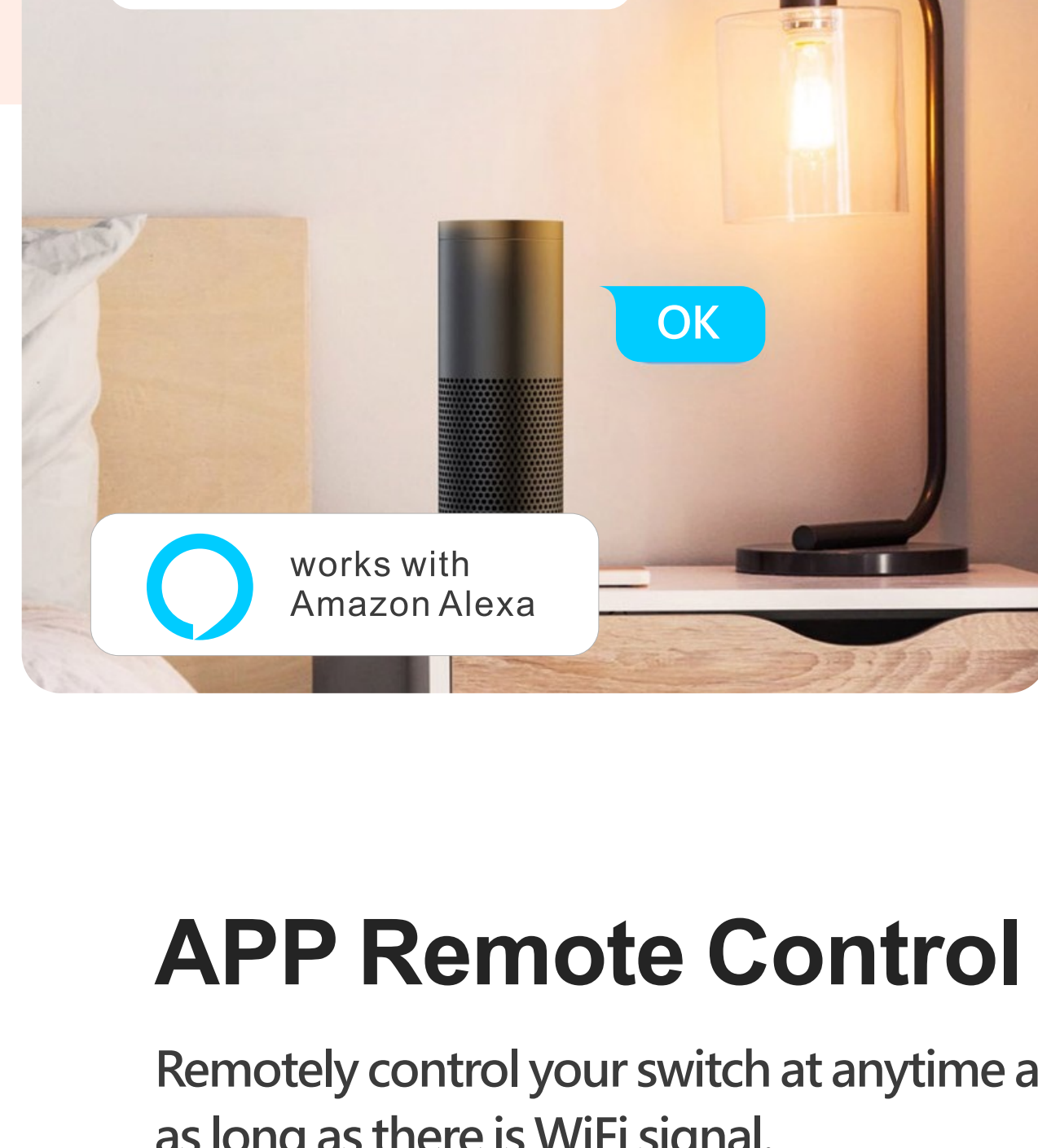

## APP Remote Control

Remotely control your switch at anytime and anywhere,  
as long as there is WiFi signal.

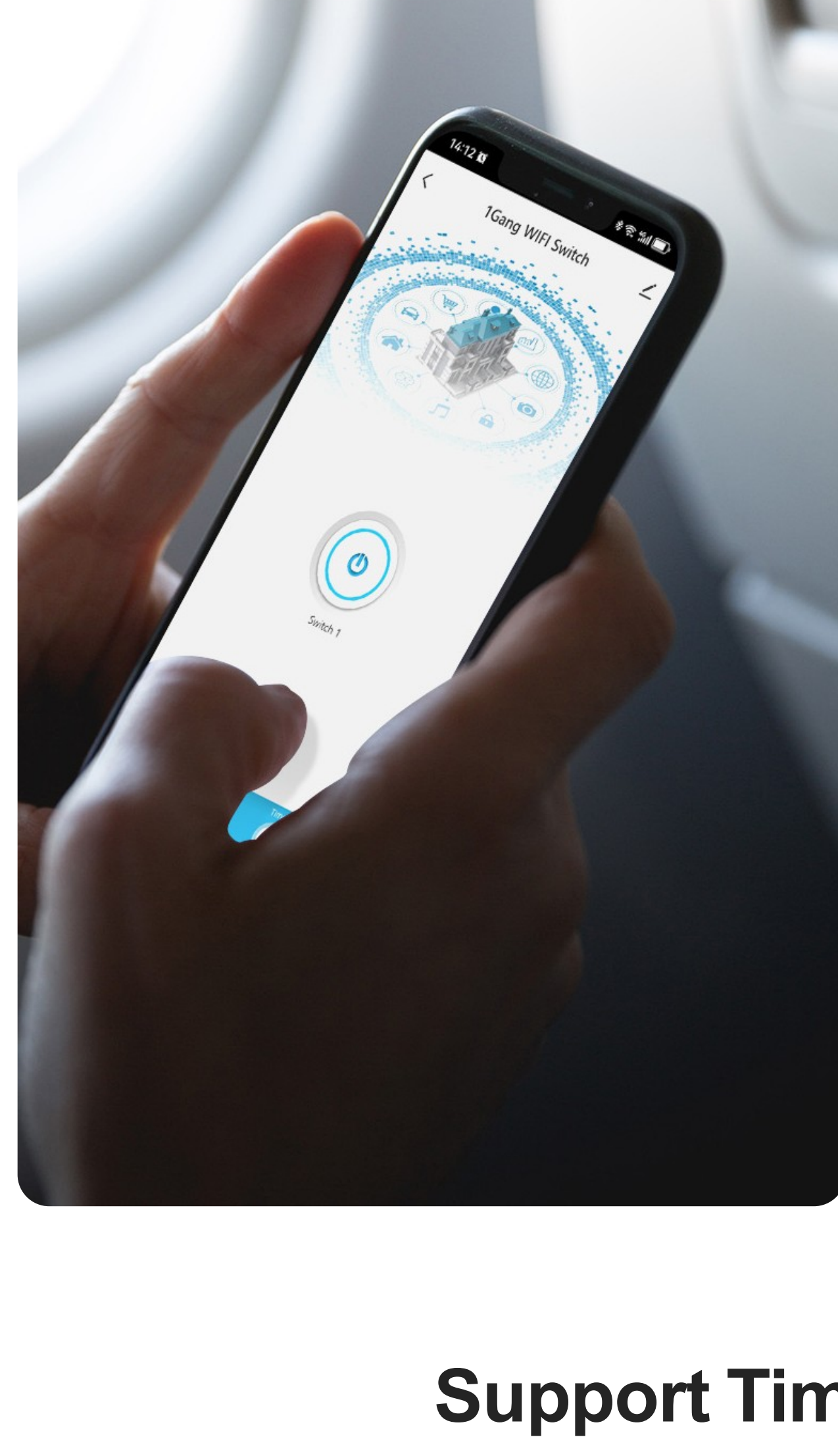

## Support Timing Function

Intelligent timing settings, don't worry about forgetting

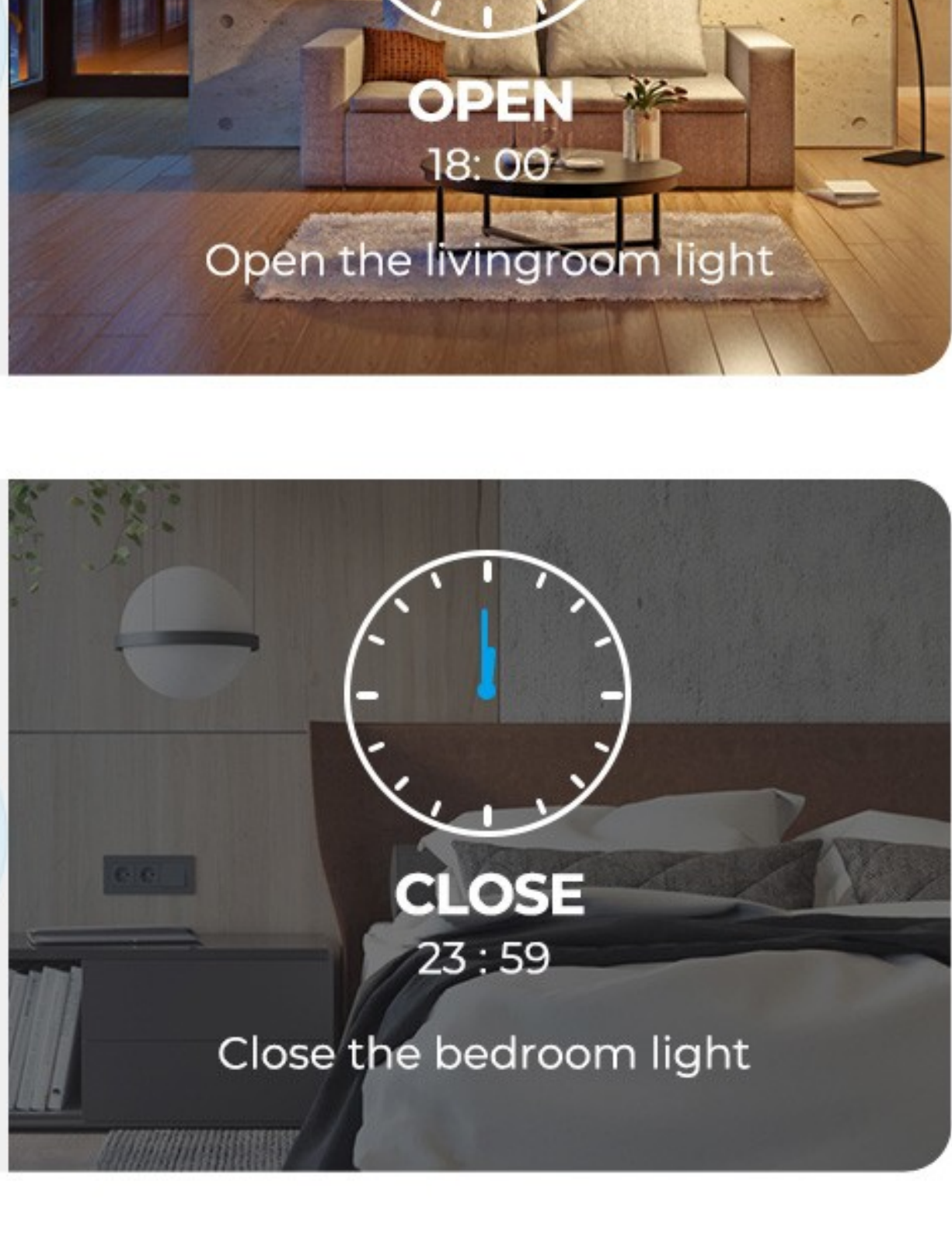
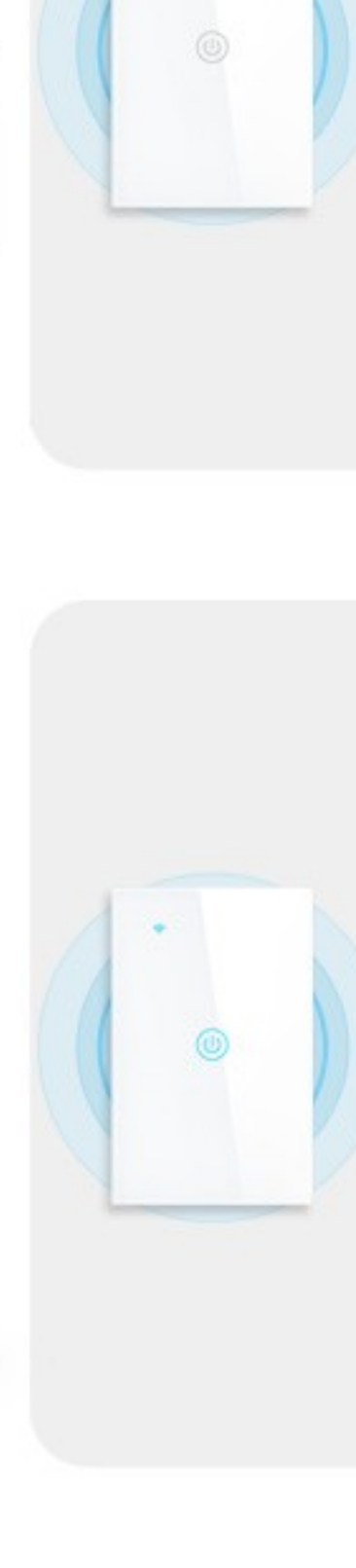
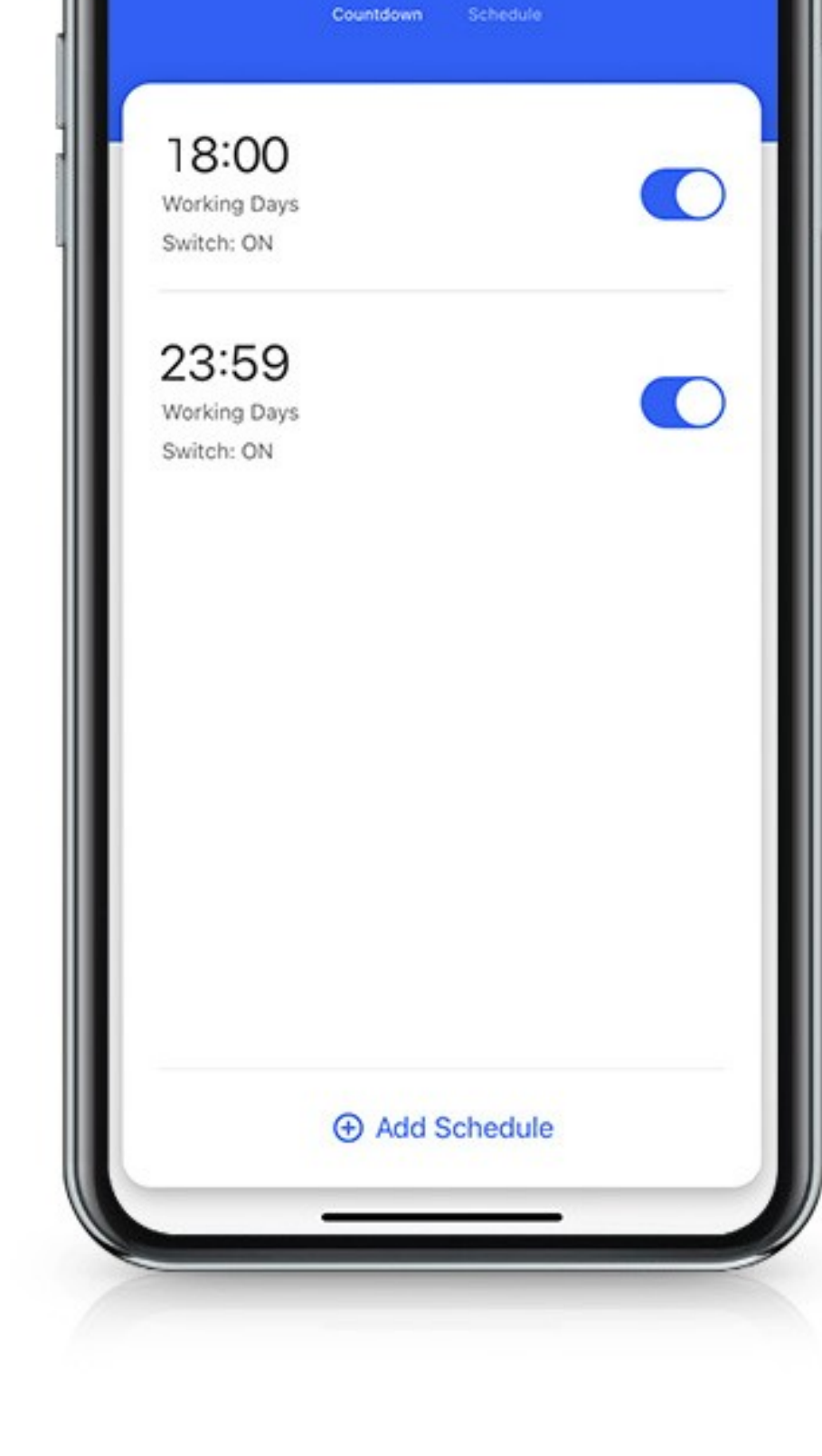

## On/Off Relay Status in App

More personalized settings as ON/OFF/Remember last status when power off.

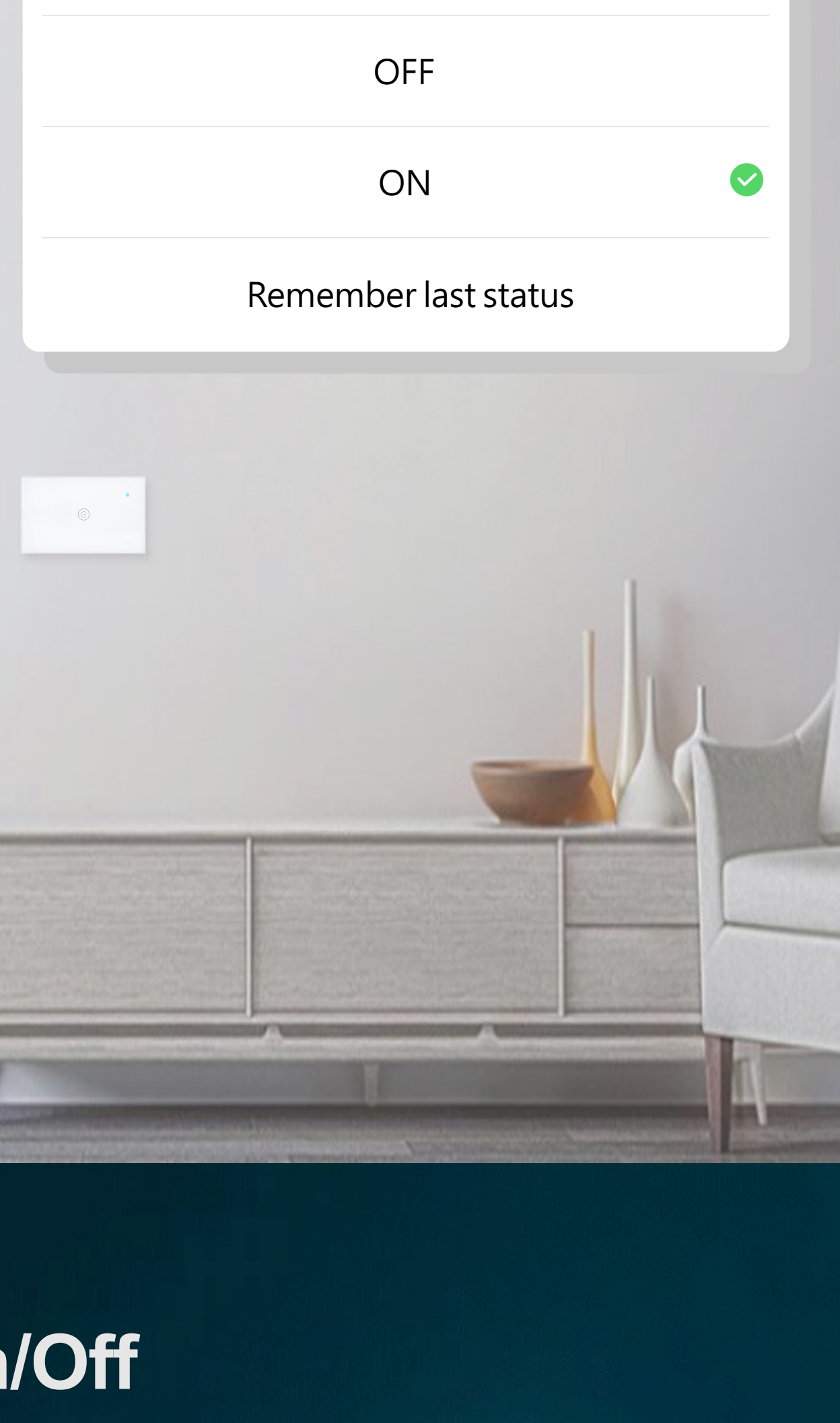
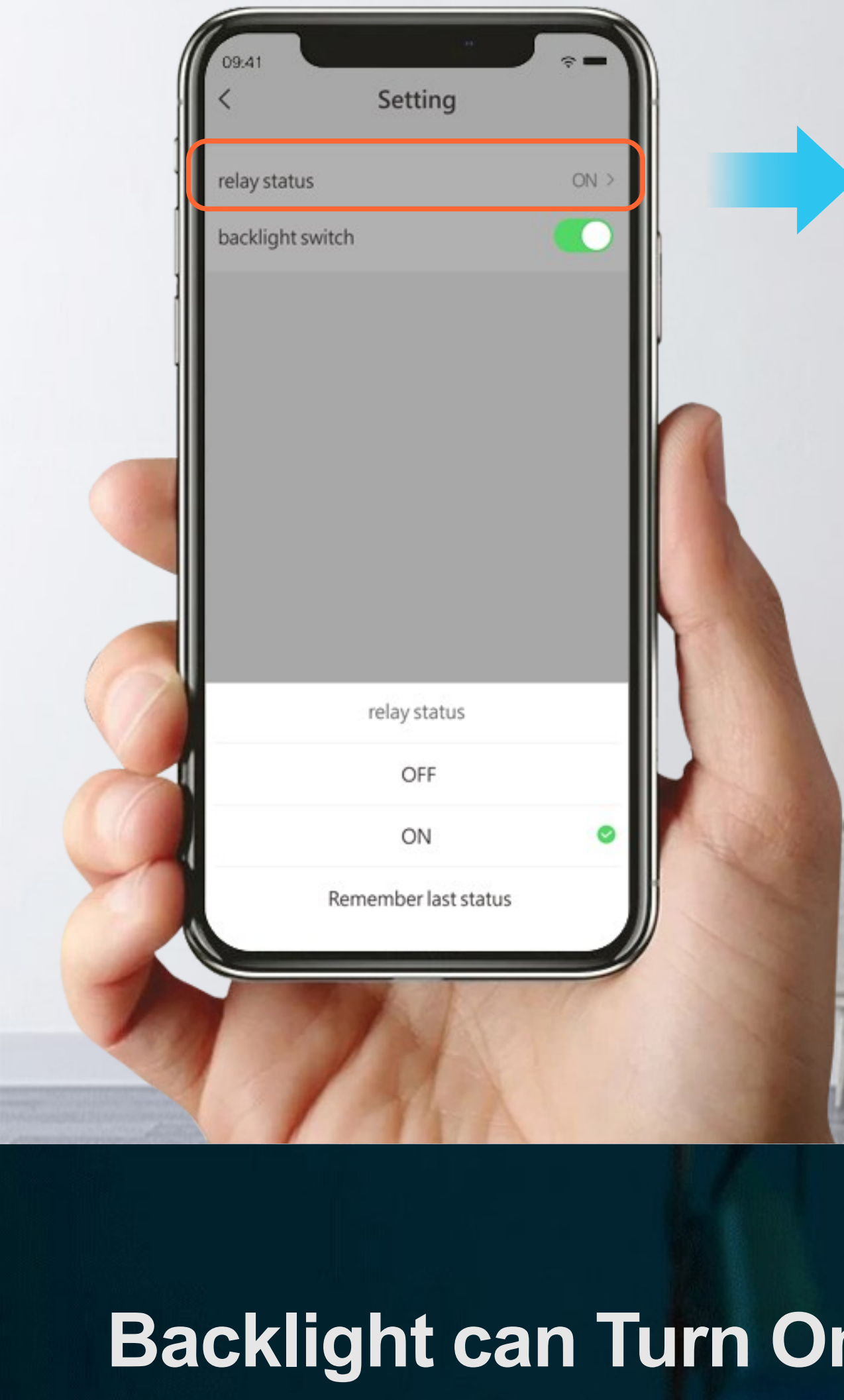

## Backlight can Turn On/Off

To avoid disturbing sleep,  
you can choose to turn off the backlight

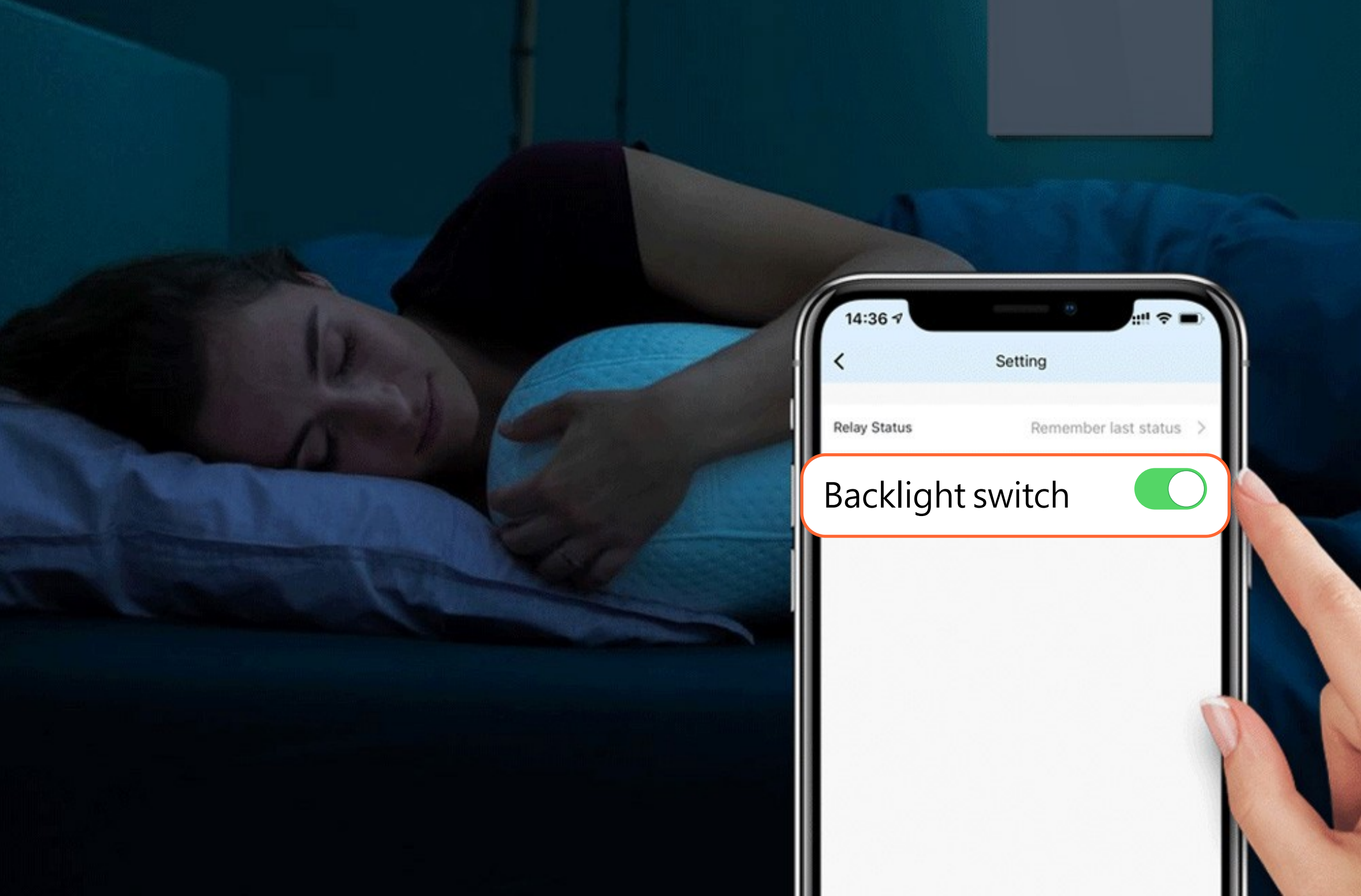

## LED Indicator

Humanization design, with soft LED indicator, can find the position of the switch easily in darkness.



ON



OFF

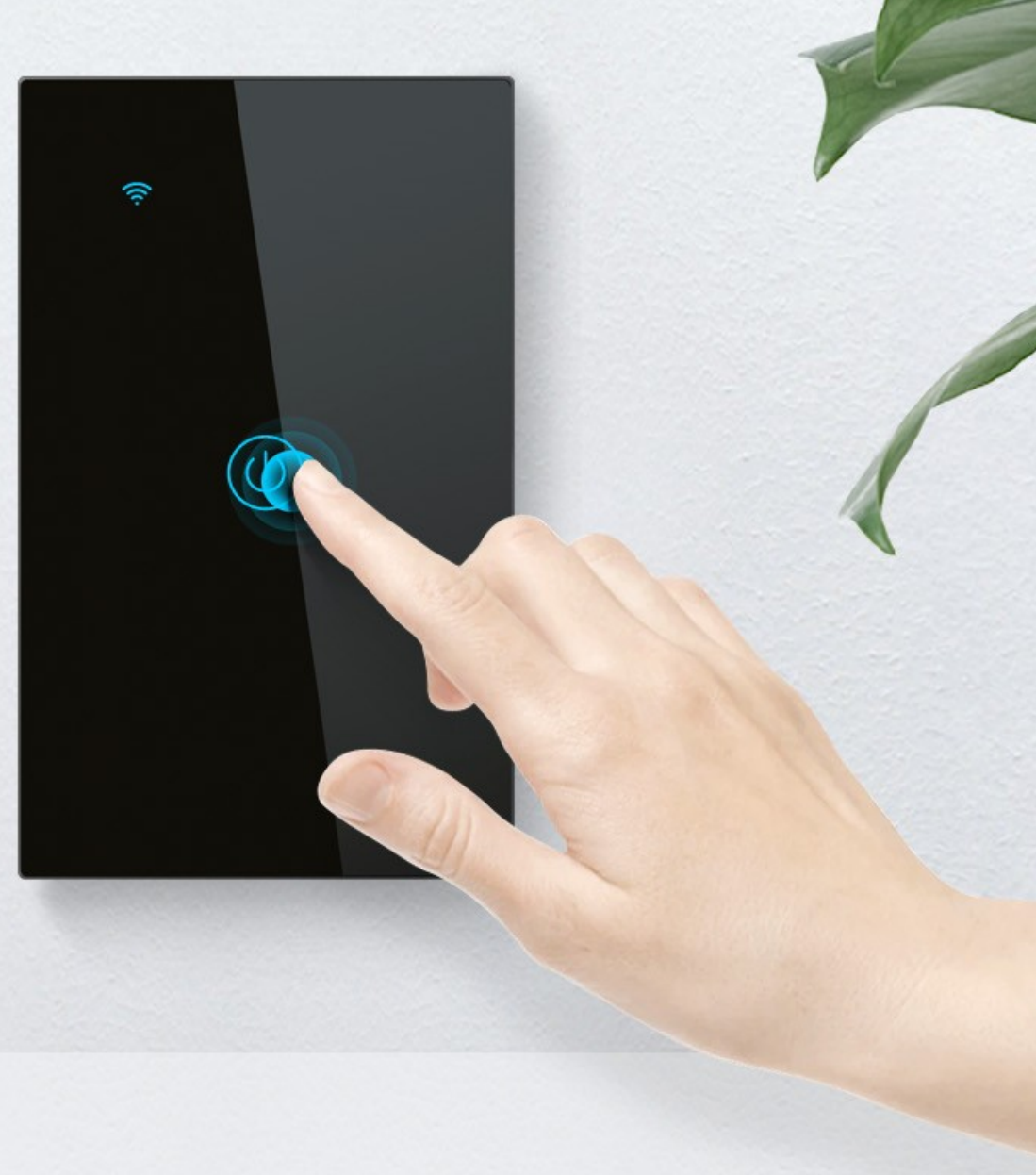

## Crystal Edge

Exquisite Craftwork  
Well polished luxurious experience  
We focus on the details



You can create group in the APP to manage all the lights in your house and share the device to your family members



Multiple people control one



One person controls more than one

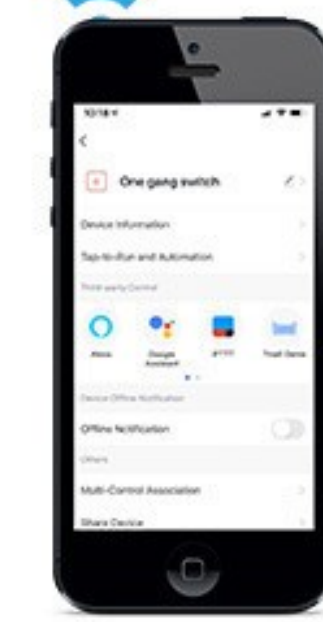
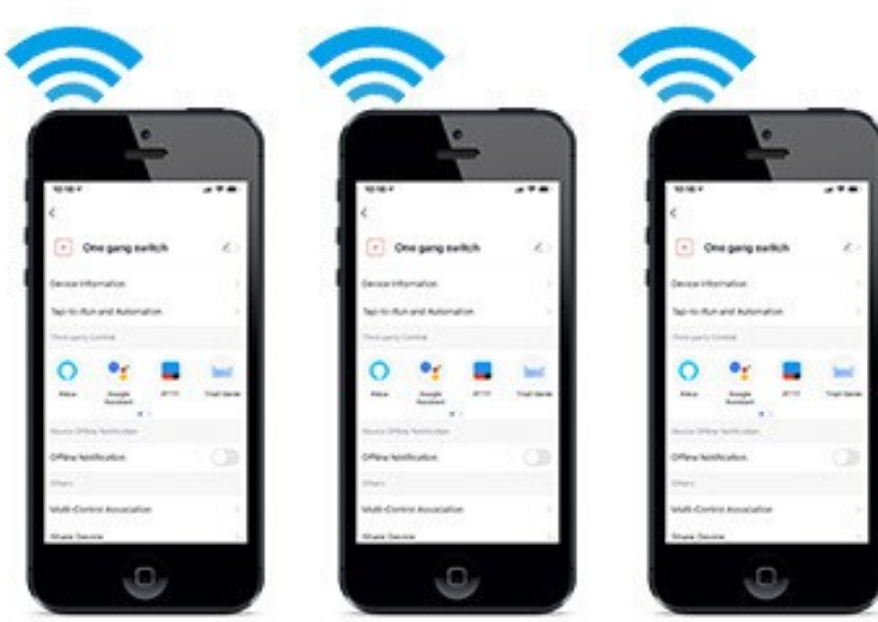
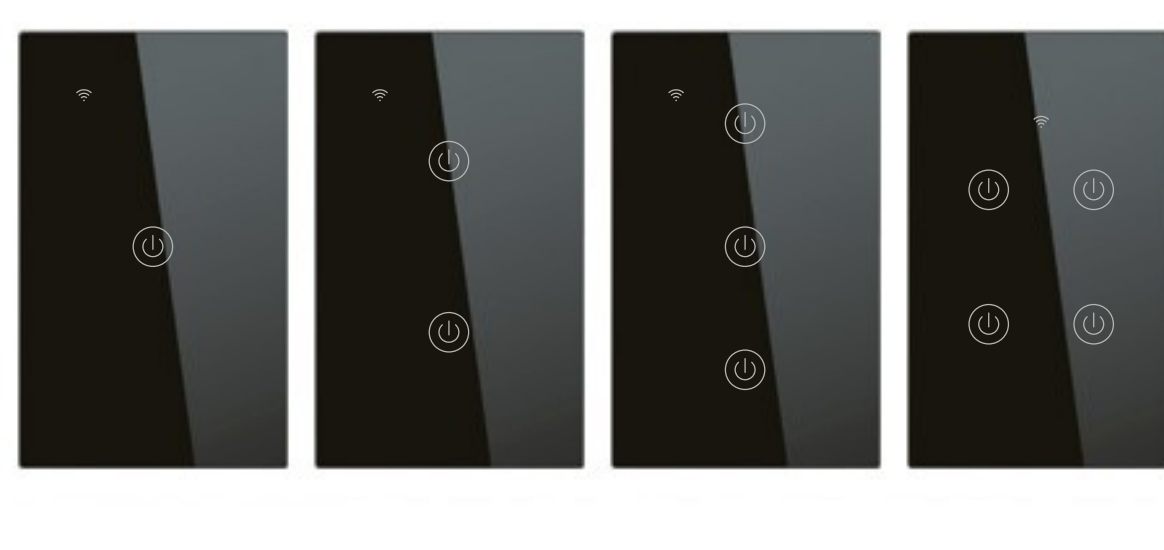

Horizontal / Vertical, easily choose the installation method

Multiple color options, suitable for various decoration styles



## Four Color Options

Default Color: White/Black

Options: Gold/Grey

Black

White

Gold

Grey



## Product Appearance & Size

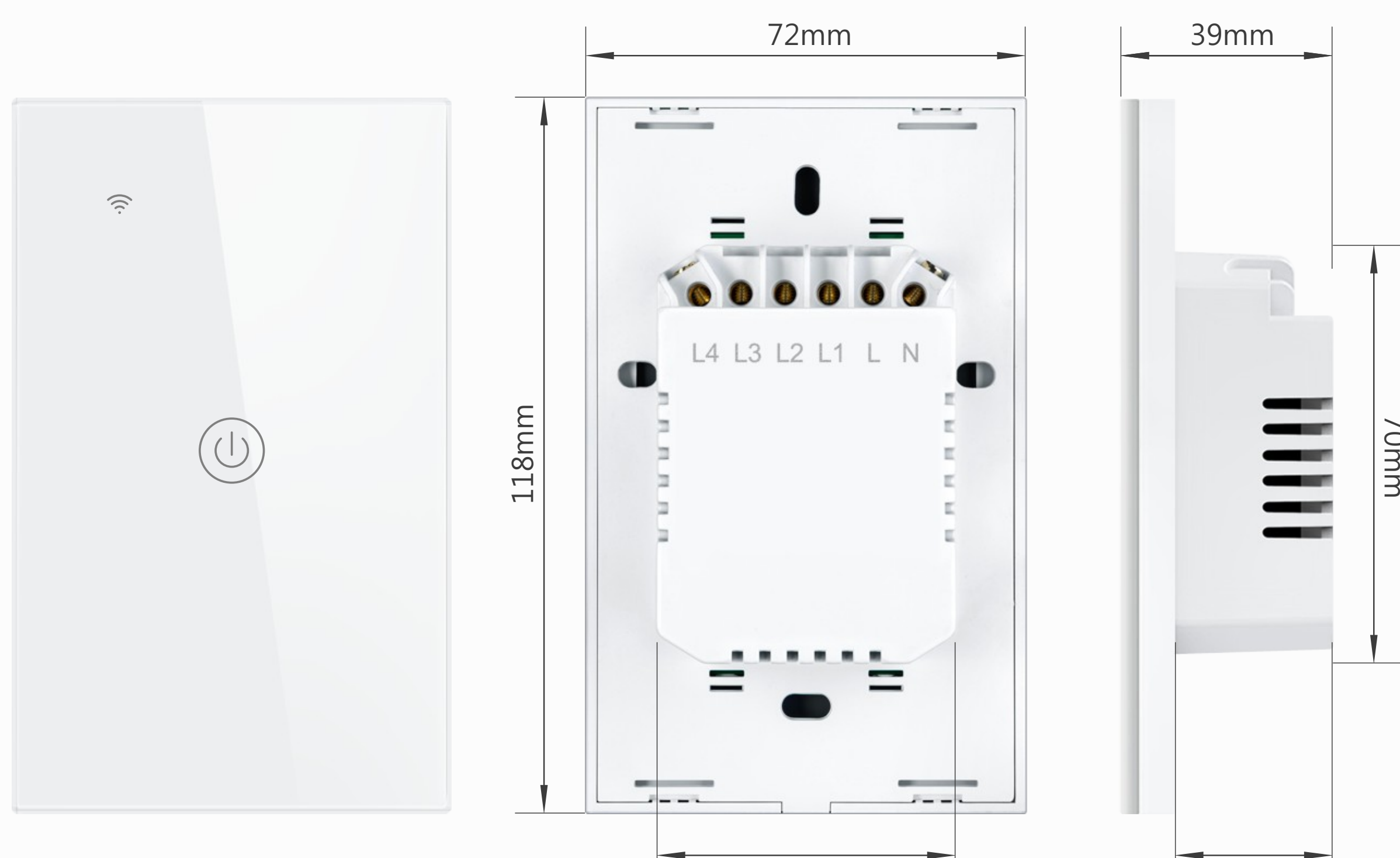

WiFi Frequency

2.4G Hz b/g/n

Work Voltage

AC100-240V

50/60Hz

Rated Power

10-400W

## Work with or without neutral wire

① Need neutral

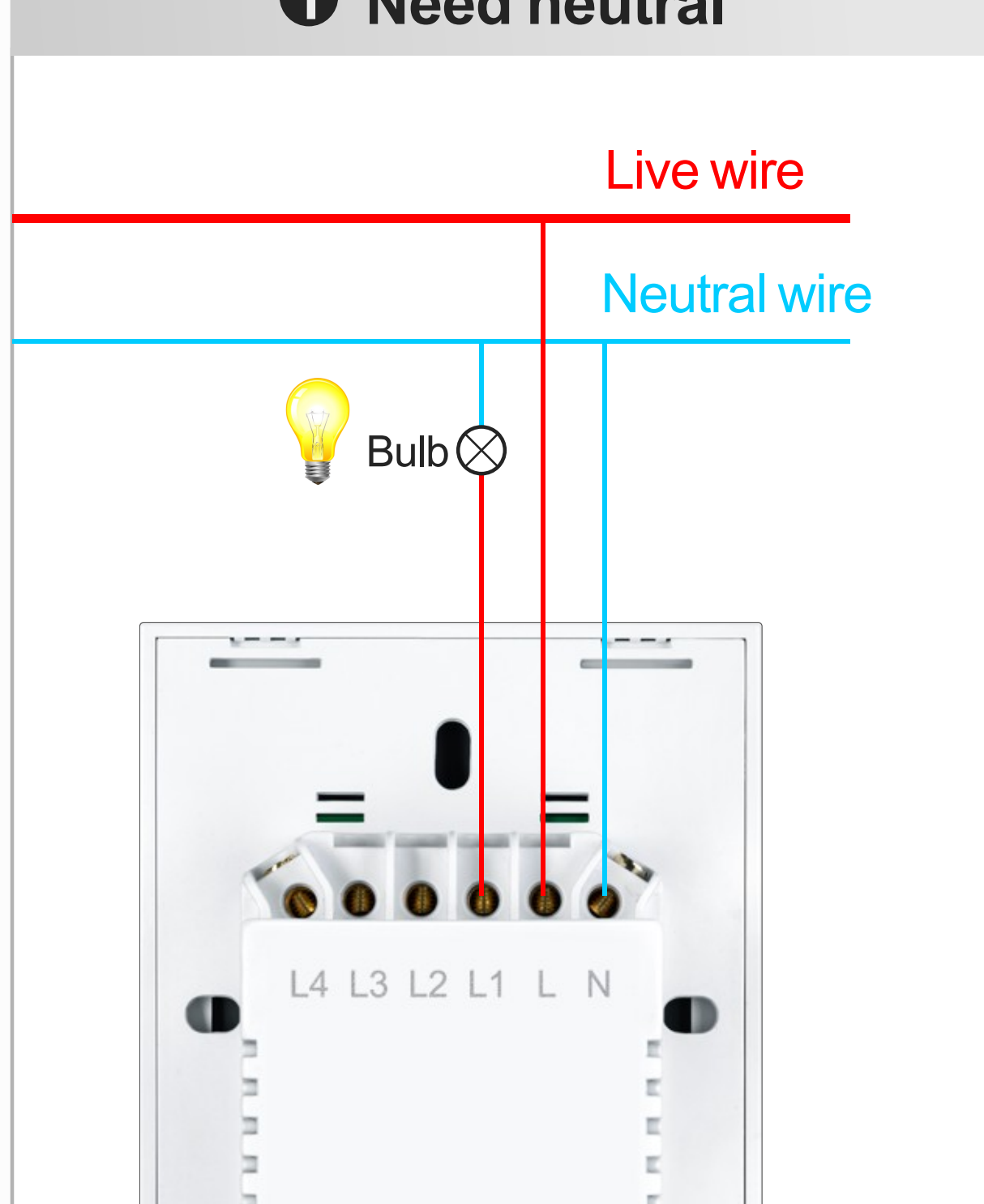

② No need neutral

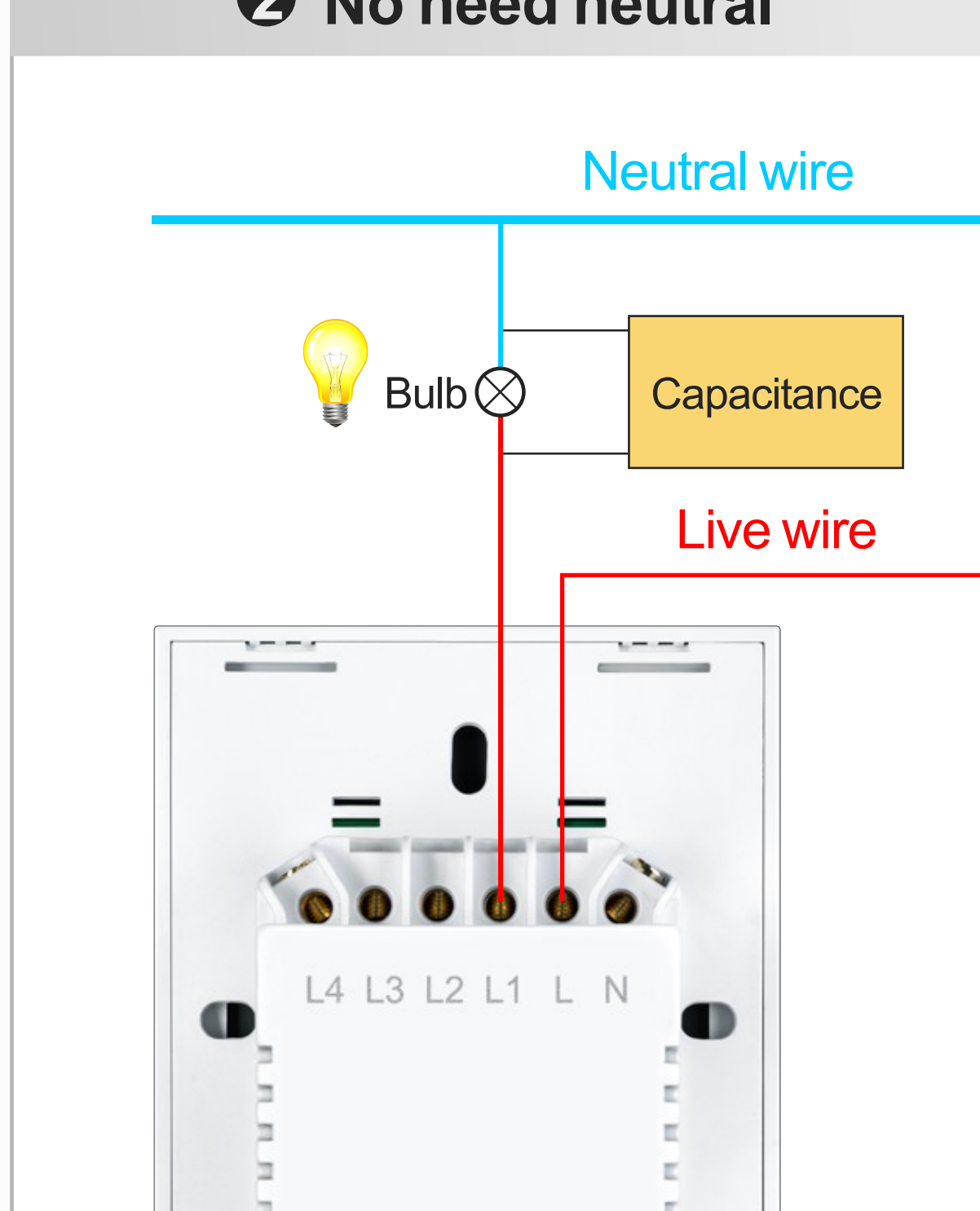

## Description

Tuya Smart 1 CH WIFI US Touch Switch for Home Lamps

Support Voice Control: Work with Amazon Alexa/Google Assistance

Work Voltage: 100-240V AC 50/60Hz

Rated Power: 10-400W

Material Panel: tempered glass panel, Fire restriction PC back shell

Default Color: White/Black; Options: Gold/Grey

With neutral line & without neutral line both can be used

Box: 140\*90\*55mm, Unit weight: 0.238kg

## 1/2/3/4 Gang Optional

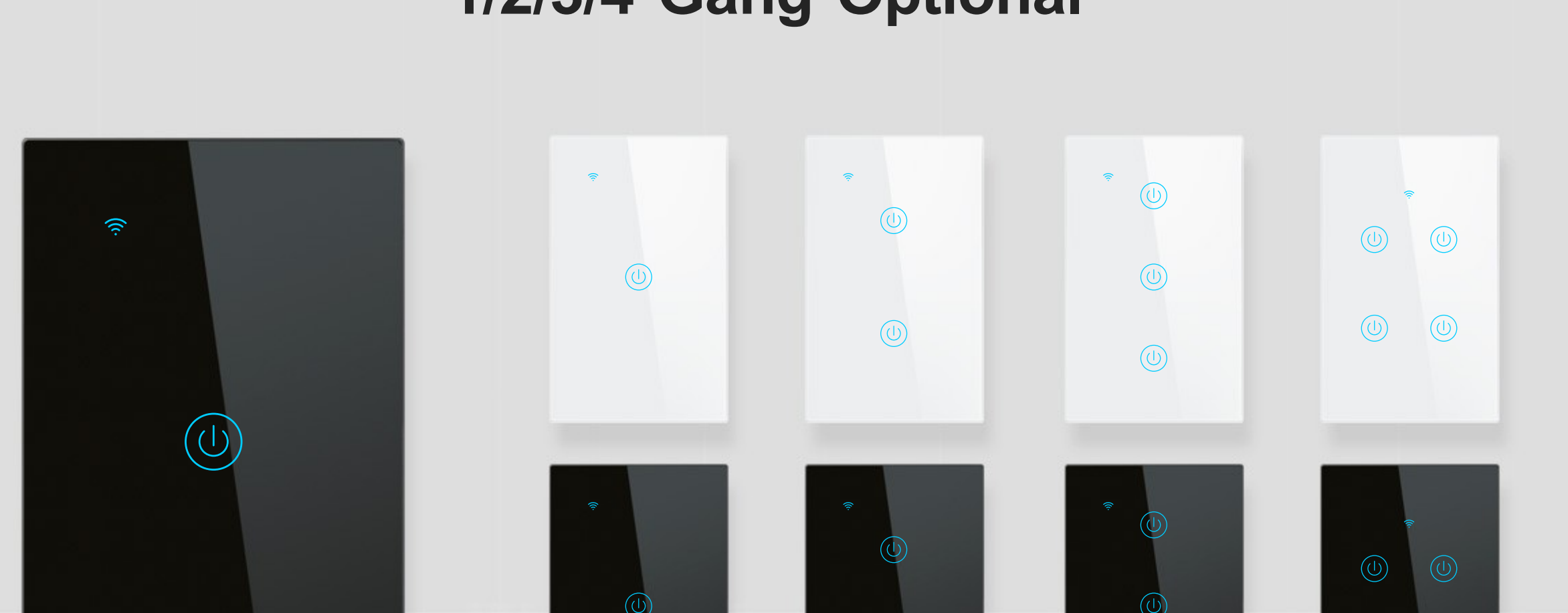

US Standard

1-Gang

2-Gang

3-Gang

4-Gang